

4

3

2

1

A

B

C

D

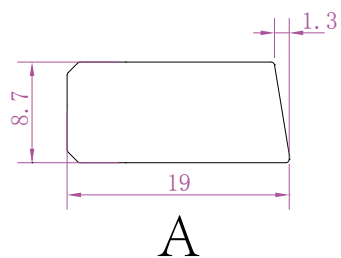
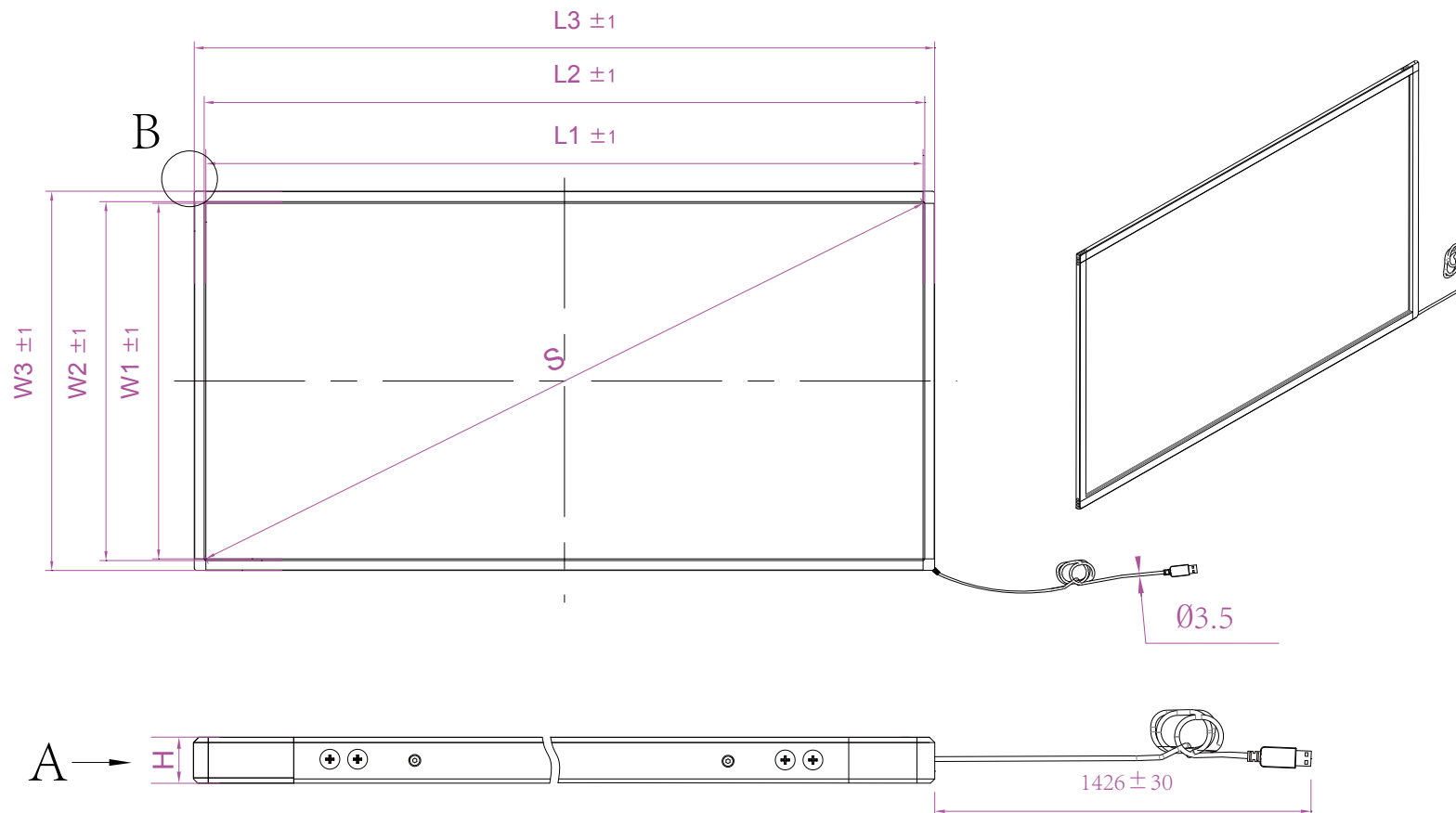
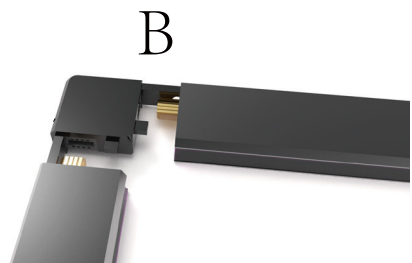

S(Inch/mm)	31.74"/806.4
W1	$395.8 \pm 1$
W2	$398.4 \pm 1$
W3	$433.8 \pm 1$
L1	$702.6 \pm 1$
L2	$705.2 \pm 1$
L3	$740.6 \pm 1$
H	$8.7 \pm 0.2$



Anti-Sunlight, No Blind Zone For Any Size



X Slim Series							
Material:	aluminum	Unit:	mm	Date:		Rev:	1.0
Draft by:		Approved by:					

4

3

2

1