

4

3

2

1

A

B

C

D

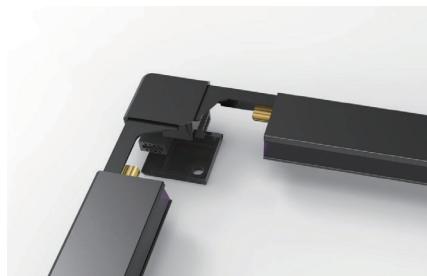

B

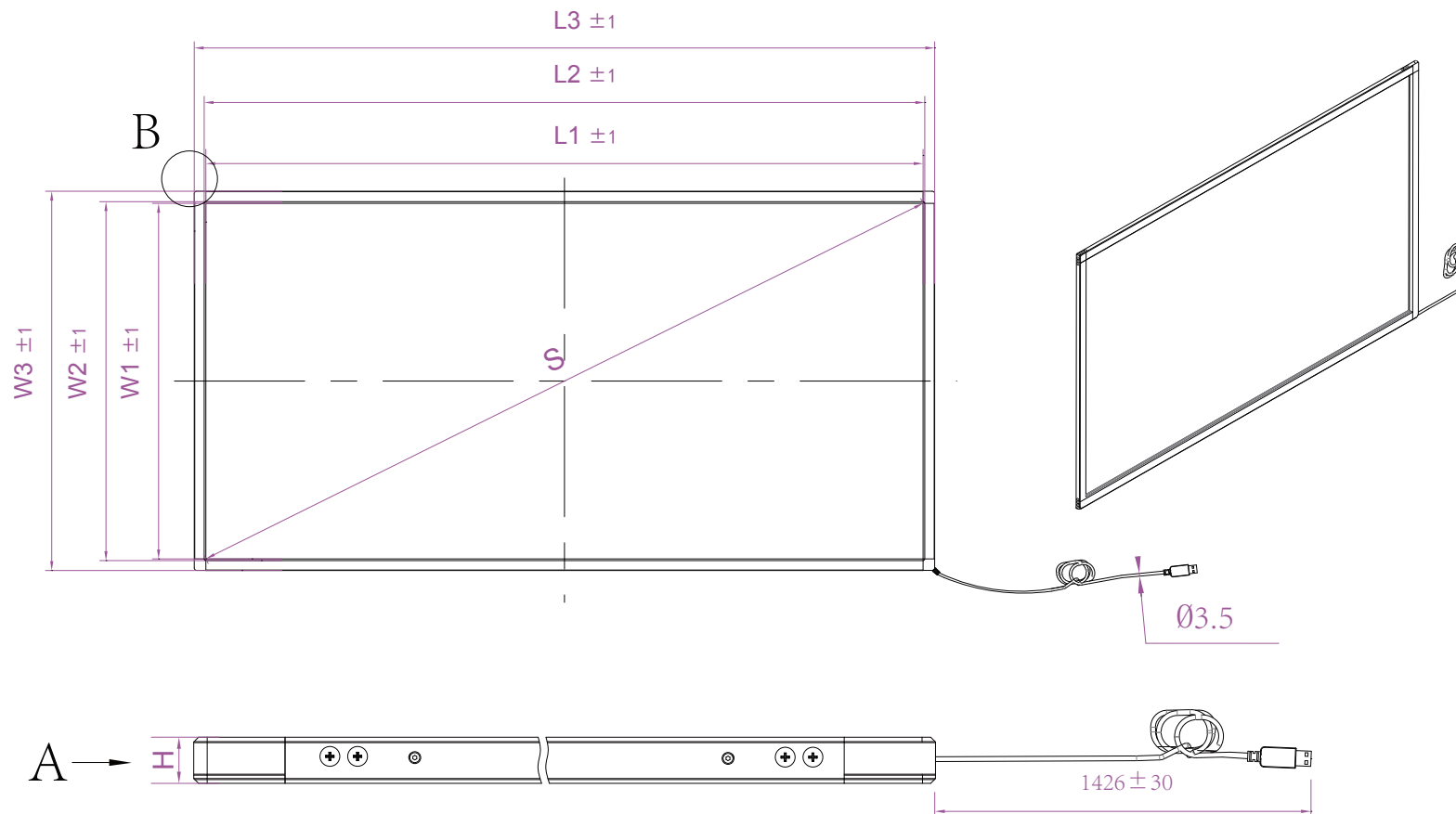

Ø3.5

1426 ± 30

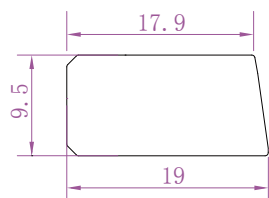

A

S(Inch/mm)	84.27"/2140.52
W1	1050.7 ± 1
W2	1052.9 ± 1
W3	1088.7 ± 1
L1	1864.9 ± 1
L2	1867.1 ± 1
L3	1902.9 ± 1
H	9.5 ± 0.2



Anti-Sunlight, No Blind Zone For Any Size



X Slim Series

Material:	aluminum	Unit:	mm	Date:		Rev:	1.0
Draft by:		Approved by:					

4

3

2

1